

Proportional pressure relief valve type VPDB (size 16)

operating pressure p_{\max} 350 bar
 volume flow V_{\max} 150 L/min

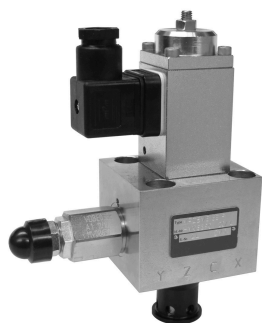

Product characteristics

Pressure-limiting valves are a type of pressure control valve. They safeguard the system against excessive system pressure or limit the operation pressure.

Features and benefits:

- hydraulically pilot controlled plug-in valve for continuous adjustment of pressure
- As a controller, the electronic digital amplifiers PVR2 and PVR6 by HAWE are recommended – specially designed for this type of valve.

Table of Contents

Technical data	2
Characteristic lines	4
Dimensions and connections	5
Order information	6
Contact details.....	6

Technical data

General

weight	2,2 kg
ambient temperature	-30 to +50 °C
mounting position	arbitrary

Hydraulic parameters

operating pressure	P, T, X: max. 350 bar Y: pressureless to tank
volume flow	8 - 150 L/min
temperature hydraulic fluid	-25 to +70 °C
viscosity	10-600 mm ² /s
permissible degree of pollution	max. class 10 according NAS 1638
filter recommendation	filter retention rate $\beta_{25} > 75$
pilot oil	~ 1.3 L/min
hysteresis	7-10 % without dither < 5 % with dither
repeatability	< 1 %

Electrical parameters

actuation	electromagnetic with proportional solenoid
nominal voltage	24 V
voltage	DC
control current	50-680 mA
limiting current	680 mA
coil resistance	25.7 Ω (20 °C)
duty cycle	continuous operation
protection class	IP65 with plug (DIN 40050)
connection	connector (DIN43650-AF2-PG9)

Characteristic lines

measured at 23 °C temperature of hydraulic fluid, viscosity 35 mm²/s, deviation ±5 %

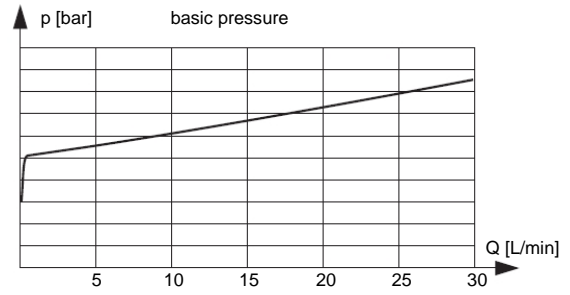
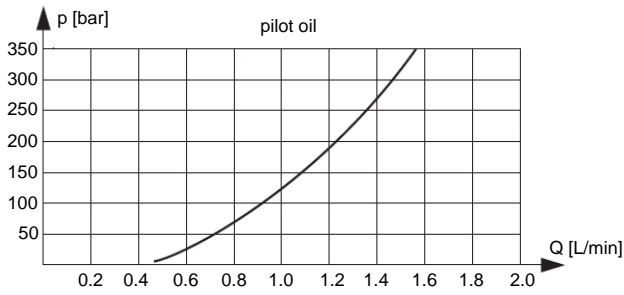
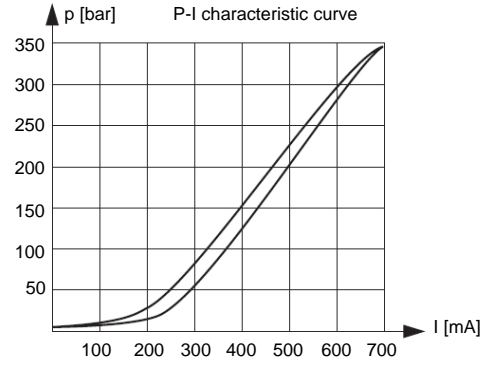
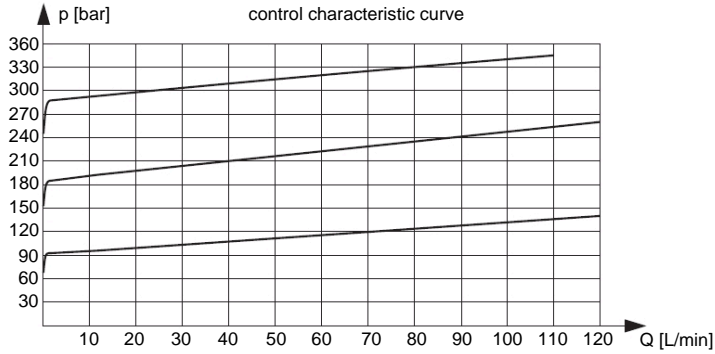

Dimensions and connections

Dimensions are given in mm.

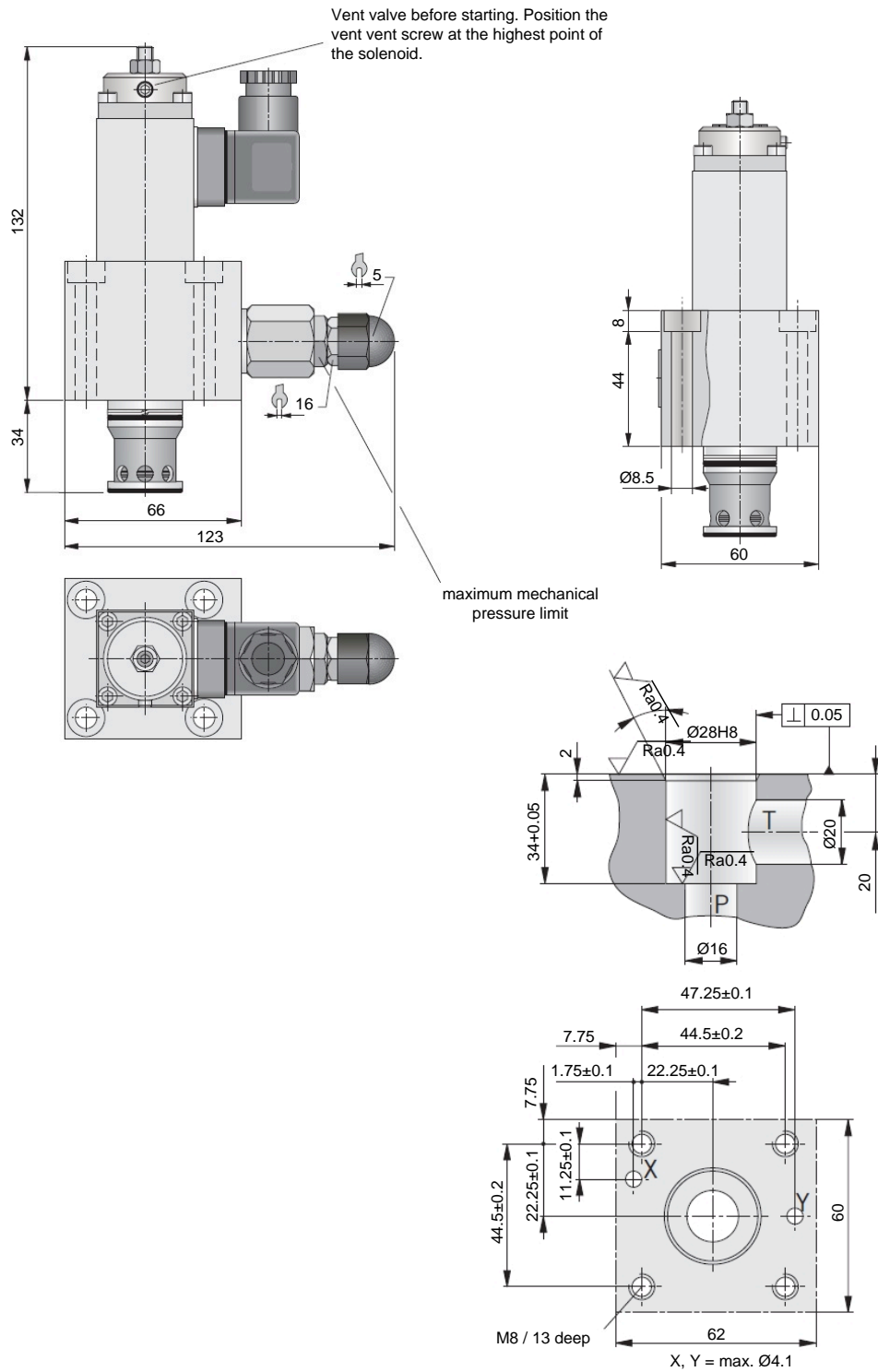

Order information

Type code

VPDB	VE16	E
		pressure range E: 20 - 350 bar
	size VE16	see dimensions
type	proportional pressure-limiting valve	

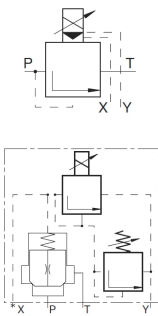

Contact details

Headquarters

HAWE Hydraulik SE
Einsteinring 17
85605 Aschheim
Germany

e-mail: info@hawe.de
www.hawe.com

Phone: +49 (0) 89 / 37 91 00 - 1000

Contact to the Customer Service

Phone (Head office)	+ 49 (0) 89 / 37 91 00 - 1000
Phone (Spare parts)	+ 49 (0) 89 / 37 91 00 - 1302
Phone (Customer Service)	+ 49 (0) 89 / 37 91 00 - 1491
Fax (Customer Service)	+ 49 (0) 89 / 37 91 00 - 91491
e-mail	spareparts@hawe.de service@hawe.de