

Throttle valve and shut-off valve type AV

Product documentation



Operating pressure p_{\max} :

500 bar

Flow rate Q_{\max} :

100 lpm



© by HAWE Hydraulik SE.

The reproduction and distribution of this document as well as the use and communication of its contents to others without explicit authorisation is prohibited.

Offenders will be held liable for the payment of damages.

All rights reserved in the event of patent or utility model applications.

Brand names, product names and trademarks are not specifically indicated. In particular with regard to registered and protected names and trademarks, usage is subject to legal provisions.

HAWE Hydraulik respects these legal provisions in all cases.

Printing date / document generated on: 13.08.2020

Contents

1	Throttle valve and shut-off valve type AV overview.....	4
2	Available versions, main data.....	5
3	Parameters.....	6
3.1	General.....	6
4	Dimensions.....	9
5	Assembly, operation and maintenance recommendations.....	10
5.1	Intended use.....	10
5.2	Assembly information.....	10
5.3	Operating instructions.....	11
5.4	Maintenance information.....	11

1**Throttle valve and shut-off valve type AV overview**

Throttle and shut-off valves are a type of metering valve. With the aid of these valves a pressure drop can be established between the inlet and outlet side. In this way the velocity of cylinders in accumulator circuits and the flow rate in control circuits can be regulated or a consumer line completely shut-off (e.g. to protect a pressure gauge).

The throttle and shut-off valve type AV produces a throttle effect by means of an annular gap. It is available as a screw-in valve or valve for pipe connection.

Features and benefits:

- Various configurations
- Sensitive adjustment and complete shut off possible

Intended applications:

- General hydraulic systems



Valve for pipe connection



Screw-in valve

2 Available versions, main data

Circuit symbol:

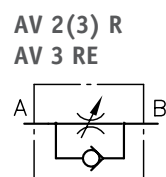
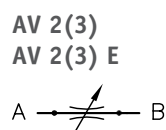

Marking	Description	Ports	Flow rate Q_{\max} (lpm)	Pressure range p_{\max} (bar)	
AV 2 E	Screw-in valve	Series	40	500	
AV 3 E		with check valve	M40x1.5	100	400
AV 3 RE					
AV 2	Valve for pipe connection	Series	G 1/2 (BSPP)	40	500
AV 3		with check valve	G 3/4 (BSPP)	100	400
AV 2 R			G 1/2 (BSPP)	40	500
AV 3 R		G 3/4 (BSPP)	100	400	

3.1 General

General information

Description	Throttle valve and shut-off valve
Design	Cone valve
Model	Screw-in valve, valve for pipe connection
Material	Steel parts electrogalvanised
Installation position	As desired
Flow direction	A → B
Hydraulic fluid	Hydraulic oil: according to Part 1 to 3; ISO VG 10 to 68 according to DIN ISO 3448 Viscosity limits: min. approx. 4, max. approx. 1500 mm ² /s opt. operation approx. 10... 500 mm ² /s. Also suitable for biologically degradable hydraulic fluids type HEPG (polyalkylene glycol) and HEES (synthetic ester) at operating temperatures up to approx. +70°C.
Cleanliness level	ISO 4406 <u>21/18/15...19/17/13</u>
Temperatures	Ambient: approx. -40 ... +80°C, Fluid: -25 ... +80°C, Note the viscosity range! Permissible temperature during start: -40°C (observe start-viscosity!), as long as the service temperature is at least 20K higher for the following operation. Biologically degradable pressure fluids: Observe manufacturer's specifications. By consideration of the compatibility with seal material not over +70°C.

Characteristic curves

Oil viscosity approx. 50 mm²/s

Δp -Q characteristics (middle values of throttle resistances)

The diagrams show the correlation between the flow rate Q (lpm) and the expected pressure drop Δp (bar) at a viscosity of 50 mm²/s and at different valve strokes. With different viscosities, the families of straight lines move slightly to the left (thicker oil) or to the right (thinner oil). The diagrams therefore only provide indicative values and should be helpful when determining valve sizes.

AV 2, AV 2 E, AV 2 R

Flow direction A → B

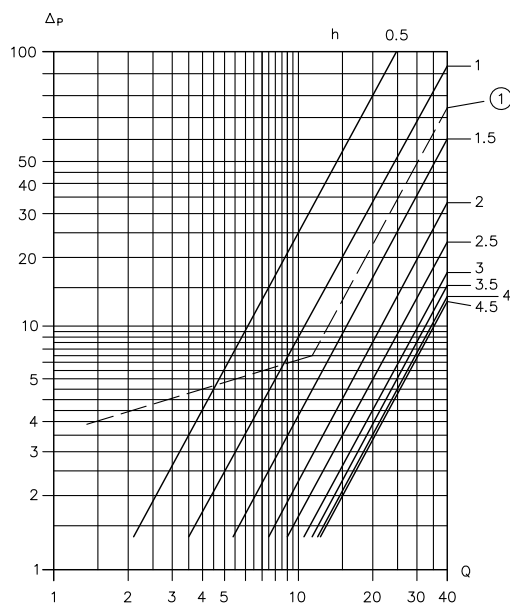

Q flow rate (lpm); Δp dynamic pressure (bar); h valve stroke (mm)

1 Flow direction B → A (Type AV 2 R)

AV 3, AV 3 E, AV 3 R, AV 3 RE

Flow direction A → B

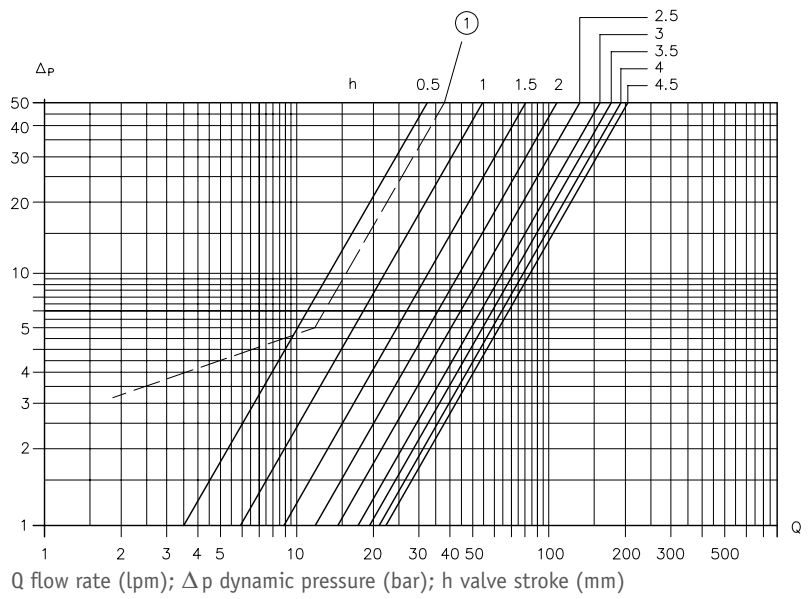

1 Flow direction B → A (Type AV 3 R)

Weight

Type

AV 2 E	= 0.6 kg
AV 3 E	= 1.0 kg
AV 3 RE	= 1.2 kg
AV 2	= 0.6 kg
AV 3	= 1.7 kg
AV 2 R	= 0.6 kg
AV 3 R	= 1.7 kg

4 Dimensions

All dimensions in mm, subject to change.

Screw-in valve

AV 2 E, AV 3 E, AV 3 RE

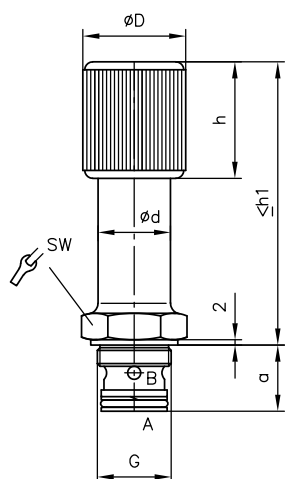

Pipe connection

AV 2, AV 3, AV 2 R, AV 3 R

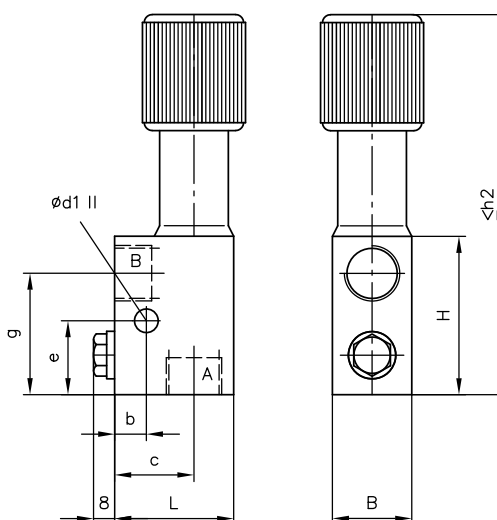

Mounting hole

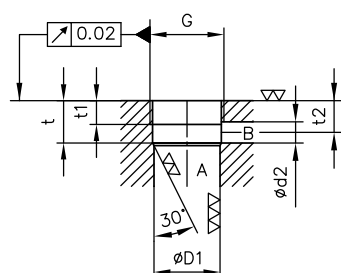

Type	Connections (ISO 228-1(BSPP)) A, B
AV 2	G 1/2
AV 3	G 3/4

Type	L	H	B	ØD	ØD1	a	b	c	ød	ød1	ød2	e	g	h	h1	h2
AV 2 E	45	60	30	40	25 ^{H8}	25	12	30	26	9	8	28	46	45	115	145
AV 3 E AV 3 RE	60	70	40	50	36 ^{H8}	38	15	40	35	11	12	30	52	60	143	198
AV 2 AV 2 R	45	60	30	40	--	25	12	30	26	9	--	28	46	45	115	145
AV 3 AV 3 R	60	70	40	50	--	38	15	40	35	11	--	30	52	60	153	198
	t	t1	t2	G	SW											
AV 2 E	16	9	12	M28x1.5	36											
AV 3 E AV 3 RE	26	14	18	M40x1.5	46											

5.1 Intended use

This valve is exclusively intended for hydraulic applications (fluid engineering).

The user must observe the safety measures and warnings in this documentation.

Essential requirements for the product to function correctly and safely:

- All information in this documentation must be observed. This applies in particular to all safety measures and warnings.
- The product must only be assembled and put into operation by qualified personnel.
- The product must only be operated within the specified technical parameters. The technical parameters are described in detail in this documentation.
- All components must be suitable for the operating conditions in the event of application in an assembly.
- The operating and maintenance manual of the components, assemblies and the specific complete system must also always be observed.

If the product can no longer be operated safely:

1. Remove the product from operation and mark it accordingly.
- ✓ It is then not permitted to continue using or operating the product.

5.2 Assembly information

The product must only be installed in the complete system with standard and compliant connection components (screw fittings, hoses, pipes, fixtures etc.).

The product must be shut down correctly prior to dismantling (in particular in combination with hydraulic accumulators).

**DANGER**

Risk to life caused by sudden movement of the hydraulic drives when dismantled incorrectly!

Risk of serious injury or death.

- Depressurise the hydraulic system.
- Perform safety measures in preparation for maintenance.

5.3 Operating instructions

Note product configuration and pressure / flow rate

The statements and technical parameters in this documentation must be strictly observed.
The instructions for the complete technical system must also always be followed.

i NOTE

- Read the documentation carefully before usage.
- The documentation must be accessible to the operating and maintenance staff at all times.
- Keep documentation up to date after every addition or update.

⚠ CAUTION

Risk of injury due to unexpected movement processes in the machine due to incorrect flow setting!

Risk of minor injury

- Be prepared for unexpected, fast movements. On changing the flow settings, consumers will move more slowly or more quickly.
- Always monitor the pressure gauge when setting or changing the flow.

Purity and filtering of the hydraulic fluid

Fine contamination can significantly impair the function of the hydraulic component. Contamination can cause irreparable damage.

Examples of fine contamination include:

- Metal chips
- Rubber particles from hoses and seals
- Dirt due to assembly and maintenance
- Mechanical debris
- Chemical ageing of the hydraulic fluid

i NOTE

Neue Druckflüssigkeit vom Hersteller hat nicht unbedingt die erforderliche Reinheit.
Beim Einfüllen von Druckflüssigkeit ist diese zu filtern.

In order to maintain faultless operation, ensure that the cleanliness level of the hydraulic fluid is correct.
(See Cleanliness level in [Chapter 3, "Parameters"](#))

Additionally applicable document: [D 5488/1](#) Oil recommendations

5.4 Maintenance information

Conduct a visual inspection at regular intervals, but at least once per year, to check if the hydraulic connections are damaged. If external leakages are found, shut down and repair the system.

Clean the device surface of dust deposits and dirt at regular intervals, but at least once per year.

Further information

Additional versions

- Shut-off valve type AVT and AVM: D 7690
- Throttle valve and shut-off valve CAV: D 7711